

REM4A Series ◊ Regulated DIP16 & SMD

4W ◊ Isolated Single & Dual Output ◊ 2:1 Input

FEATURES

- 2MOPP, 250VAC working voltage isolation
- Clearance and creepage distance $\geq 8\text{mm}$
- Up to 5kVAC/1min reinforced insulation
- IEC/EN/UL 60601 and 62368-1 certified
- -40°C to $+80^{\circ}\text{C}$ operation, no derating
- 2:1 wide input range
- Compact 24.3x14.4mm footprint
- 3 year warranty



Dimensions (LxWxH): 24.3 x 14.4 x 10.2mm (0.95 x 0.57 x 0.40 inch)
7.0g (0.015 lbs)

APPLICATIONS

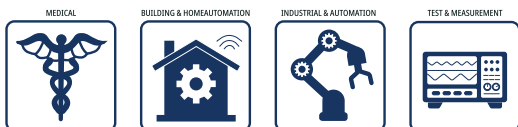

SAFETY & EMC



DESCRIPTION

The REM4A series of medical grade regulated DC/DC converters features reinforced 250VAC continuous working isolation with $\geq 8\text{mm}$ creepage/clearance. The compact DIP16/SMD package offers industry standard pinouts with tightly regulated single/dual outputs and UVLO, SCP, and OVP. The operating ambient temperature range is at nominal inputs without derating. The converters are UL marked and certified to IEC, EN, and ANSI/AAMI 60601 3rd Ed. Safety and 4th Ed. EMC medical standards as well as IEC, EN, UL 62368-1 IT and multimedia standards. The low $2\mu\text{A}$ leakage current complies with medical applied part for B, BF, and CF rating limits as defined by IEC60601-1.

SELECTION GUIDE

Part Number	Input Voltage	Output Voltage	Output Current	Efficiency	max. Capacitive
	Range [VDC]	nom. [VDC]	max. [mA]	typ. ⁽¹⁾ [%]	Load ⁽²⁾ [μF]
REM4A-0505S ⁽³⁾	4.5-12	05	700	77	1470
REM4A-0509S ⁽³⁾	4.5-12	09	389	78	680
REM4A-0512S ⁽³⁾	4.5-12	12	292	82	470
REM4A-0515S ⁽³⁾	4.5-12	15	234	82	330
REM4A-0524S ⁽³⁾	4.5-12	24	146	82	170
REM4A-0512D ⁽³⁾	4.5-12	± 12	± 146	82	± 220
REM4A-0515D ⁽³⁾	4.5-12	± 15	± 117	81	± 160

REM4A Series ◊ Regulated DIP16 & SMD

4W ◊ Isolated Single & Dual Output ◊ 2:1 Input

SELECTION GUIDE

Part Number	Input Voltage Range [VDC]	Output Voltage nom. [VDC]	Output Current max. [mA]	Efficiency typ. ⁽¹⁾ [%]	max. Capacitive Load ⁽²⁾ [µF]
REM4A-1205S ⁽³⁾	9-18	05	700	79	1470
REM4A-1209S ⁽³⁾	9-18	09	389	79	680
REM4A-1212S ⁽³⁾	9-18	12	292	82	470
REM4A-1215S ⁽³⁾	9-18	15	234	82	330
REM4A-1224S ⁽³⁾	9-18	24	146	82	170
REM4A-1212D ⁽³⁾	9-18	±12	±146	82	±220
REM4A-1215D ⁽³⁾	9-18	±15	±117	82	±160
REM4A-2405S ⁽³⁾	18-36	05	700	79	1470
REM4A-2409S ⁽³⁾	18-36	09	389	80	680
REM4A-2412S ⁽³⁾	18-36	12	292	83	470
REM4A-2415S ⁽³⁾	18-36	15	234	83	330
REM4A-2424S ⁽³⁾	18-36	24	146	82	170
REM4A-2412D ⁽³⁾	18-36	±12	±146	82	±220
REM4A-2415D ⁽³⁾	18-36	±15	±117	82	±160
REM4A-4805S ⁽³⁾	36-75	05	700	79	1470
REM4A-4809S ⁽³⁾	36-75	09	389	80	680
REM4A-4812S ⁽³⁾	36-75	12	292	82	470
REM4A-4815S ⁽³⁾	36-75	15	234	82	330
REM4A-4824S ⁽³⁾	36-75	24	146	82	170
REM4A-4812D ⁽³⁾	36-75	±12	±146	82	±220
REM4A-4815D ⁽³⁾	36-75	±15	±117	82	±160

Note1: Efficiency is tested at minimum input and full load at +25°C ambient

Note2: Max Cap Load is tested at nominal input an full resistive load

MODEL NUMBERING



Note3: without suffix = DIP16 type

with suffix "/SMD"= for SMD package

BASIC CHARACTERISTICS (measured @ T_{AMB}= 25°C, nom. V_{IN}, full load and after warm-up unless otherwise stated)

Parameter	Condition	Min.	Typ.	Max.
Internal Input Filter				capacitor
Input Voltage Range	nom. V _{IN} = 5VDC	4.5VDC	5VDC	12VDC
	nom. V _{IN} = 12VDC	9VDC	12VDC	18VDC
	nom. V _{IN} = 24VDC	18VDC	24VDC	36VDC
	nom. V _{IN} = 48VDC	36VDC	48VDC	75VDC
Input Surge Voltage	1 sec. max	nom. V _{IN} = 5VDC		15VDC
		nom. V _{IN} = 12VDC		25VDC
		nom. V _{IN} = 24VDC		50VDC
		nom. V _{IN} = 48VDC		100VDC

REM4A Series \diamond Regulated DIP16 & SMD

4W \diamond Isolated Single & Dual Output \diamond 2:1 Input



BASIC CHARACTERISTICS (measured @ $T_{AMB}= 25^{\circ}C$, nom. V_{IN} , full load and after warm-up unless otherwise stated)

Parameter	Condition		Min.	Typ.	Max.
Under Voltage Lockout (UVLO)	nom. $V_{IN}= 5VDC$	DC-DC ON			4.5VDC
		DC-DC OFF	2VDC	3VDC	4VDC
	nom. $V_{IN}= 12VDC$	DC-DC ON			9VDC
		DC-DC OFF	6VDC	7VDC	8VDC
	nom. $V_{IN}= 24VDC$	DC-DC ON			18VDC
		DC-DC OFF	13VDC	15VDC	17VDC
nom. $V_{IN}= 48VDC$	DC-DC ON			36VDC	
	DC-DC OFF	29VDC	32VDC	35VDC	
Start-up Time	power up / CTRL ON/OFF		10ms		20ms
ON/OFF CTRL ⁽⁴⁾	DC-DC ON		open or high impedance		
	DC-DC OFF		2mA	3mA	4mA
Input Current of CTRL Pin	DC-DC OFF			2.5mA	
Internal Operating Frequency			100kHz		
Output Ripple and Noise	measured by 20MHz BW	$V_{OUT}= 5, 12, 15, 24VDC$		50mVp-p	
		$V_{OUT}= 48, \pm 12, \pm 15VDC$		75mVp-p	

Note4: The pin voltage is referenced to -Vin pin and CTRL pin applied current

REM4A-1205S

Efficiency vs. Load

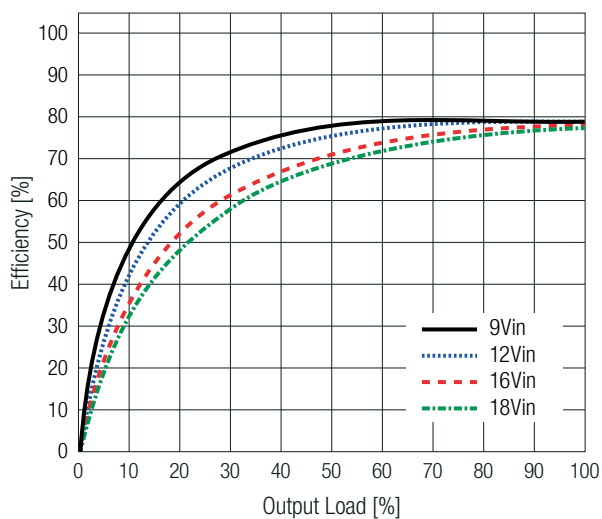

Power Dissipation vs Load

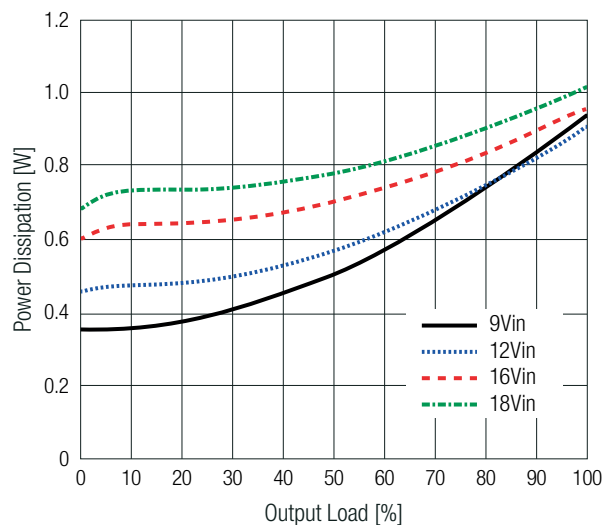

REM4A-2412S

Efficiency vs. Load

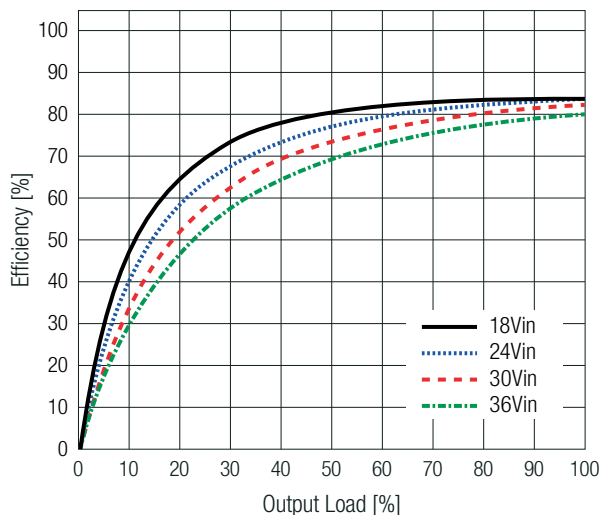

Power Dissipation vs Load

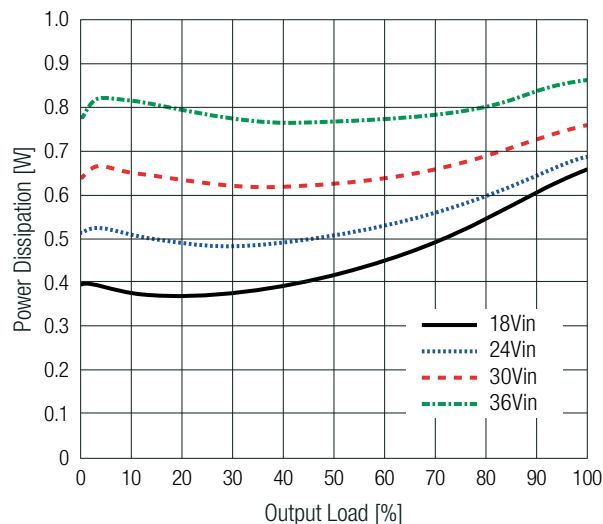

REM4A Series \diamond Regulated DIP16 & SMD

4W \diamond Isolated Single & Dual Output \diamond 2:1 Input

BASIC CHARACTERISTICS (measured @ $T_{AMB}=25^{\circ}C$, nom. V_{IN} , full load and after warm-up unless otherwise stated)

REM4A-4805S

Efficiency vs. Load

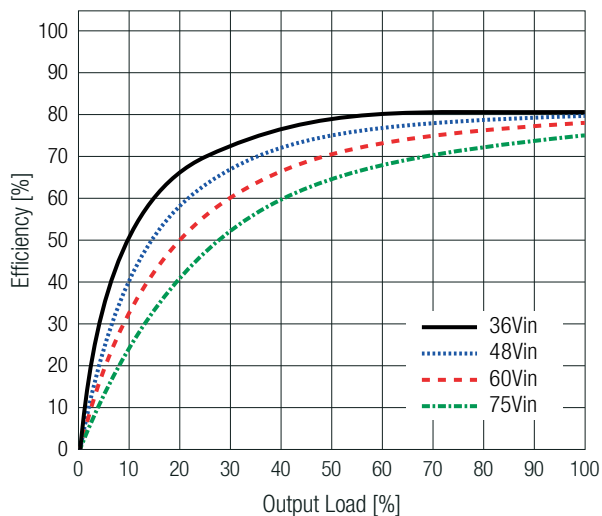

Power Dissipation vs. Load

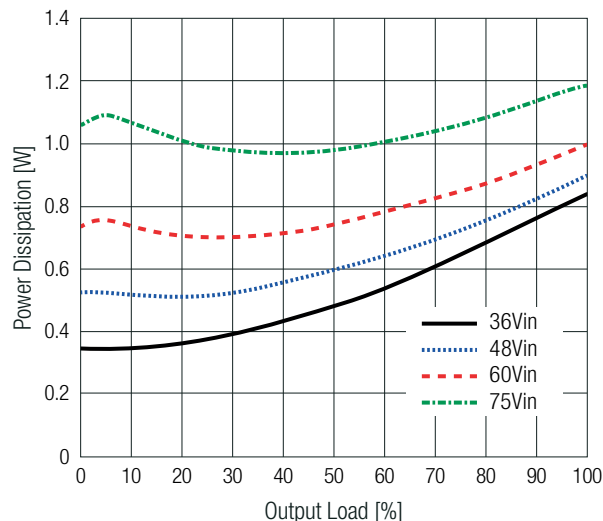

ON/OFF CTRL

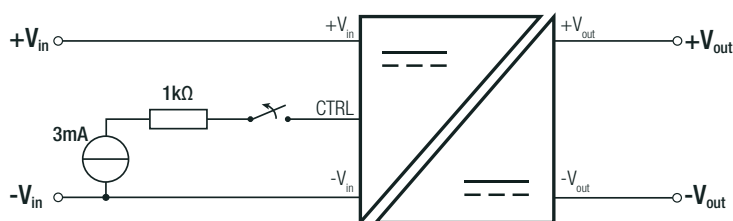

DC-DC ON: Open or high impedance

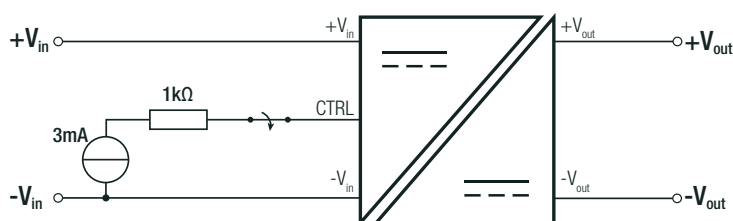

DC-DC OFF: 2mA min. / 3mA typ. / 4mA max.

REGULATIONS

Parameter	Condition	Value	
Output Accuracy		$\pm 1.0\%$ max.	
Line Regulation	low line to high line, full load	$\pm 0.2\%$ max.	
Load Regulation	0-100% load	single	$\pm 1.0\%$ max.
		dual	$\pm 1.0\%$ max.
	10-90% load	single	$\pm 0.5\%$ max.
		dual	$\pm 0.8\%$ max.
Cross Regulation	asymmetrical load 25% / full load	dual output only $\pm 5.0\%$ max.	
Transient Response	recovery time	500 μ s max.	

REM4A Series ◊ Regulated DIP16 & SMD

4W ◊ Isolated Single & Dual Output ◊ 2:1 Input

PROTECTIONS

Parameter	Condition		Value
Input Fuse ⁽⁶⁾	external		refer to below table
Short Circuit Protection (SCP)			continuous, auto recovery
Over Voltage Protection (OVP)	clamping mode	$V_{OUT} = 5VDC$	6-8VDC
		$V_{OUT} = 9VDC$	10-14VDC
		$V_{OUT} = 12VDC$	13-19VDC
		$V_{OUT} = 15VDC$	16-22VDC
		$V_{OUT} = 24VDC$	25-35VDC
Isolation Voltage ⁽⁷⁾	I/P to O/P, according to 60601-1, 62368-1	1 minute	5kVAC
Isolation Resistance	I/P to O/P, $V_{ISO} = 500VDC$		10GΩ min.
Isolation Capacitance	I/P to O/P		16pF typ. / 20pF max.
Insulation Grade			reinforced
Leakage Current	240VAC/60Hz		2μA max.
Means of Protection	250VAC working voltage		2MOPP
Medical Device Classification			built-in power supply
Internal Clearance and Creepage	I/P to O/P		≥8mm

Note7: For repeat Hi-Pot testing, reduce the time and/or the test voltage.

Note8: Refer to local safety regulations if input over-current protections is also required. Recommended fuse:

Modules	Fuse Rating [A]	Fuse Type
REM4A-05xx	1.6	slow blow
REM4A-12xx	0.8	
REM4A-24xx	0.5	
REM4A-48xx	0.315	

ENVIRONMENTAL

Parameter	Condition		Value
Operating Temperature Range	with derating and natural convection 0.1m/s	refer to „Derating Graph“	-40°C to +105°C
Maximum Case Temperature			+105°C
Temperature Coefficient			±0.02%/°C
Operating Altitude			5000m
Operating Humidity	non-condensing		5-95% RH max.
Pollution Degree			PD2
Shock, Thermal Shock, Vibration			MIL-STD-810F
MTBF	according to MIL-HDBK-217F, G.B.	$T_{AMB} = 25°C$	5041 x 10 ³ hours

Derating Graph

(@ Chamber and natural convection 0.1m/s)

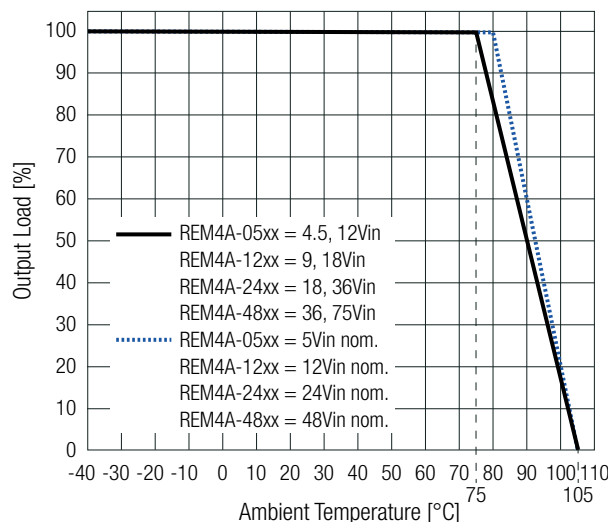

REM4A Series ◊ Regulated DIP16 & SMD

4W ◊ Isolated Single & Dual Output ◊ 2:1 Input

SAFETY AND CERTIFICATION

Certificate Type (Safety)	Report Number	Standard
Audio/video, information and communication technology equipment. Safety requirements	T01-2402024	IEC62368-1:2018 3rd Edition
Audio/video, information and communication technology equipment. Safety requirements (LVD)		EN IEC 62368-1:2020+A11:2020
Audio/video, information and communication technology equipment-Part1: Safety requirements	E196683	UL62368-1:2019 3rd Edition
		CAN/CSA-C22.2 No. 62368-1-19 3rd Edition
Medical electrical equipment Part 1: General requirements for basic safety and essential performance	E314885	ANSI/AAMI ES60601-1:2005+A2:2010/(R)2012
		CAN/CSA-C22.2 No. 60601-1:14 3rd Ed.
Medical electrical equipment Part 1: General requirements for basic safety and essential performance	T01-2402025	IEC60601-1:2005+AM1:2012 Edition 3.1
		EN60601-1:2006+A12:2014
RoHS2		RoHS 2011/65/EU + AM2015/863

EMC Compliance according to EN60601-1-2	Condition	Standard / Criterion
Medical electrical equipment Part 1-2: General requirements for basic safety and essential performance		IEC60601-1-2:2014+A1:2020 Edition 4.1 EN60601-1-2:2015+A1:2021
Industrial, scientific and medical equipment - Radio-frequency disturbance characteristics - Limits and methods of measurement	with external filter	EN55011:2016+A11:2020, Class B
ESD Electrostatic discharge immunity test	Air: ±2, 4, 8, 15kV, Contact: ±2, 4, 8kV	IEC61000-4-2:2008 EN61000-4-2:2009
Radiated, radio-frequency, electromagnetic field immunity test	10V/m (80-2700MHz)	EN IEC 61000-4-3:2020
Fast Transient and Burst Immunity ⁽⁹⁾	DC Power Port: ±2kV	IEC/EN61000-4-4:2012
Surge Immunity ⁽⁹⁾	DC Power Port: ±0.5, 1kV	IEC/EN61000-4-5:2014+A1:2017
Immunity to conducted disturbances, induced by radio-frequency fields	3, 6V (0.15-80MHz)	IEC61000-4-6:2013 EN61000-4-6:2014+AC:2015
	6V (ISM bands)	
	6V (amateur radio bands)	
Power Magnetic Field Immunity	30A/m, 100A/m	IEC61000-4-8:2009 EN61000-4-8:2010
Testing and measurement techniques - Radiated fields in close proximity - Immunity test	30kHz, 8A/m 134.2kHz, 65A/m 13.56MHz, 7.5A/m	IEC61000-4-39

EMC Compliance according to EN55032/35	Condition	Standard / Criterion
Electromagnetic compatibility of multimedia equipment – Emission Requirements	with external filter	EN55032:2015+A11:2020, Class A, B
Electromagnetic compatibility of multimedia equipment – Immunity requirements		EN55035:2017+A11:2020
ESD Electrostatic discharge immunity test	Air: ±2, 4, 8, 15kV, Contact: ±2, 4, 6, 8kV	IEC61000-4-2:2008, Criteria A EN61000-4-2:2009, Criteria A
Radiated, radio-frequency, electromagnetic field immunity test	10V/m (80-1000MHz) 10V/m (1800, 2600, 3500, 5000MHz)	EN/IEC 61000-4-3:2020, Criteria A
Fast Transient and Burst Immunity ⁽⁹⁾	DC Power Port: ±2kV	IEC/EN61000-4-4:2012, Criteria A
Surge Immunity ⁽⁹⁾	DC Power Port: ±1kV	IEC/EN61000-4-5:2014+A1:2017, Criteria A
Immunity to conducted disturbances, induced by radio-frequency fields	3Vrms (0.15-10MHz)	IEC61000-4-6:2013, Criteria A EN61000-4-6:2014, Criteria A
	3-1Vrms (10-30MHz)	
	1Vrms (30-80MHz)	
Power Magnetic Field Immunity	50/60Hz, 100A/m, 50Hz, 1000A/m	IEC61000-4-8:2009, Criteria A EN61000-4-8:2010, Criteria A

EMC Compliance according to EN61204-3	Condition	Standard / Criterion
Low voltage power supplies, d.c. output Part 3: Electromagnetic compatibility	with external filter	EN61204-3:2000, Class A, B
ESD Electrostatic discharge immunity test	Air: ±2, 4, 8, 15kV, Contact: ±2, 4, 6, 8kV	IEC61000-4-2:2008 EN61000-4-2:2009
Radiated, radio-frequency, electromagnetic field immunity test	10V/m (80-1000MHz)	EN IEC 61000-4-3:2020, Criteria A
Fast Transient and Burst Immunity ⁽⁹⁾	DC Power Port: ±2kV,	IEC/EN61000-4-4:2012, Criteria A
Surge Immunity ⁽⁹⁾	DC Power Port: ±1kV	IEC/EN61000-4-5:2014+A1:2017, Criteria A
Immunity to conducted disturbances, induced by radio-frequency fields	3Vrms (0.15-10MHz)	IEC61000-4-6:2013; EN61000-4-6:2014
	3-1Vrms (10-30MHz)	
	1Vrms (30-80MHz)	

REM4A Series \diamond Regulated DIP16 & SMD

4W \diamond Isolated Single & Dual Output \diamond 2:1 Input

SAFETY AND CERTIFICATION

Fast Transient / Surge

Note9: An external input filter capacitor is required if the module has to meet EN61000-4-4 and EN61000-4-5

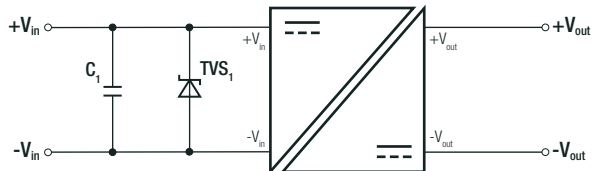

Component List

Model	C1	TVS
REM4A-05xx	1000 μ F/25V	18V/400W
REM4A-12xx	470 μ F/50V	N/A
REM4A-24xx	470 μ F/50V	N/A
REM4A-48xx	220 μ F/100V	N/A

EMC Filtering Suggestions

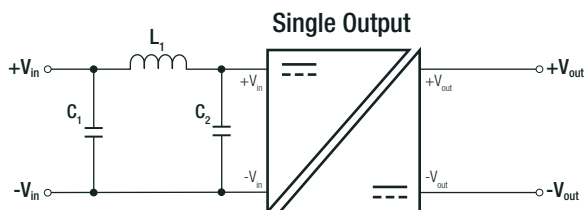

Component List Class A

Model	C1	L1	C2
REM4A-05xx	22 μ F	3.3 μ H	N/A
REM4A-12xx	10 μ F	10 μ H	N/A
REM4A-24xx	10 μ F	15 μ H	N/A
REM4A-48xx	2.2 μ F	68 μ H	N/A

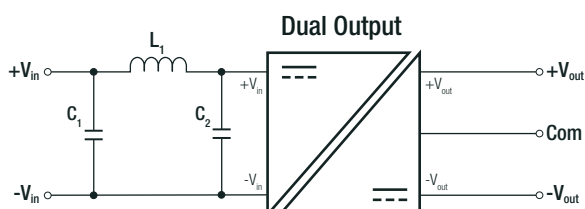

Component List Class B

Model	C1	L1	C2
REM4A-05xx	22 μ F	6.8 μ H	22 μ F
REM4A-12xx	10 μ F	10 μ H	10 μ F
REM4A-24xx	10 μ F	15 μ H	10 μ F
REM4A-48xx	2.2 μ F	68 μ H	2.2 μ F

DIMENSION & PHYSICAL CHARACTERISTICS

Parameter	Type	Value
Materials	case/ baseplate	non-conductive black plastic, (UL94 V-0)
	PCB	FR4, (UL94 V-1)
	potting	silicone, (UL94 V-0)
Dimension (LxWxH)		24.3 x 14.4 x 10.2mm 0.95 x 0.57 x 0.40inch
Weight		7g typ. 0.015lbs

REM4A Series \diamond Regulated DIP16 & SMD

4W \diamond Isolated Single & Dual Output \diamond 2:1 Input

DIMENSION & PHYSICAL CHARACTERISTICS

Dimension Drawing DIP16

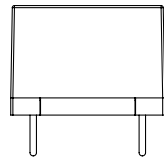
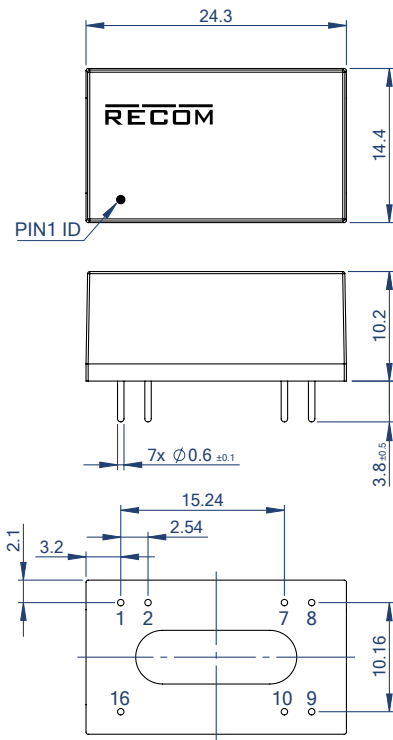
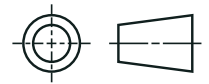

Recommended Footprint Details (Top View)

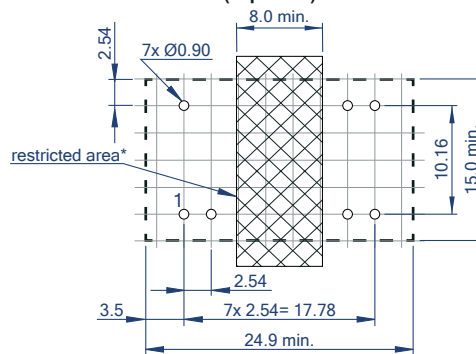

Pinning information

Pin #	Single	Dual
1	-Vin	-Vin
2	CTRL	CTRL
7	NC	NC
8	NC	Com
9	+Vout	+Vout
10	-Vout	-Vout
16	+Vin	+Vin

NC= not connected

*There should be at least 8mm distance between primary and secondary circuit

Dimension Drawing SMD

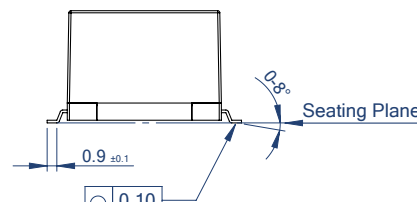
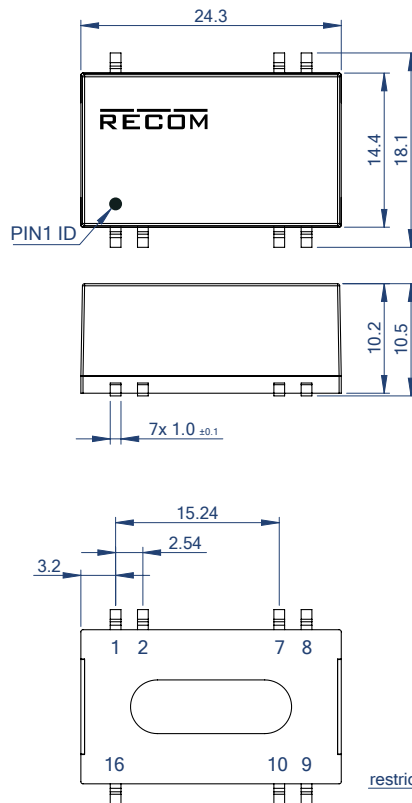

Recommended Footprint Details

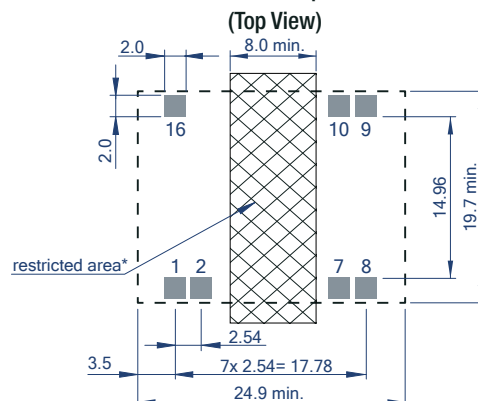

Pinning information

Pin #	Single	Dual
1	-Vin	-Vin
2	CTRL	CTRL
7	NC	NC
8	NC	Com
9	+Vout	+Vout
10	-Vout	-Vout
16	+Vin	+Vin

NC= not connected

*There should be at least 8mm distance between primary and secondary circuit

Tolerances:
 x.x= ±0.5mm
 x.xx= ±0.25mm

REM4A Series \diamond Regulated DIP16 & SMD

4W \diamond Isolated Single & Dual Output \diamond 2:1 Input

SOLDER PROFILE FOR SMD TYPE

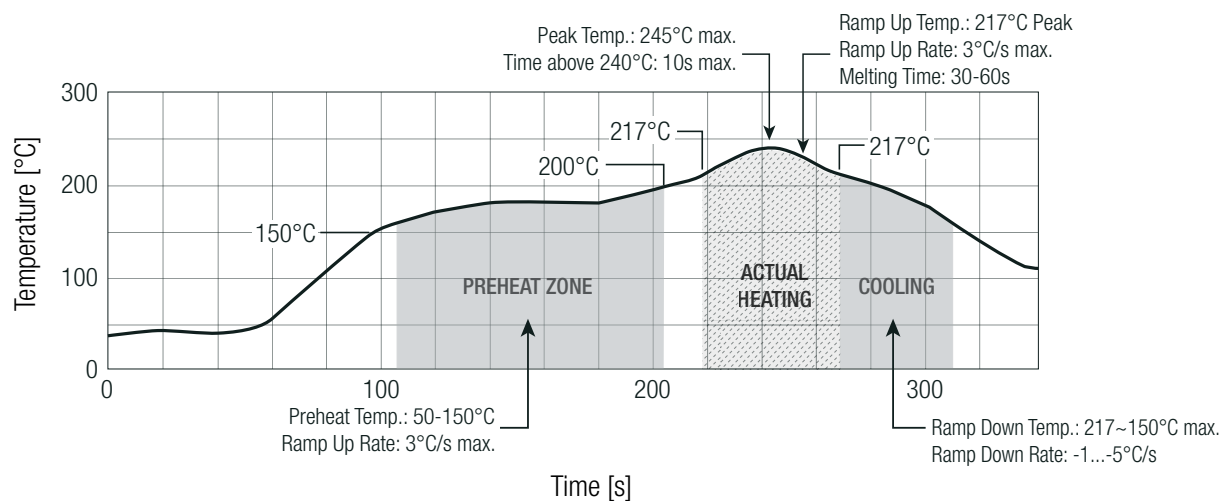

PACKAGING INFORMATION

Parameter	Type	Value
Packaging Dimension (LxWxH)	tube	290.0 x 17.35 x 25.6mm
Packaging Quantity		10pcs
Storage Temperature Range		-55°C to +125°C
Storage Humidity	non-condensing	5% - 95% RH max.
Moisture Sensitivity Level (MSL)	only for SMD type verification according to IPC J-STD-020E	IPC J-STD-033C, Level 2

The product information and specifications may be subject to changes even without prior written notice. The product has been designed for various applications; its suitability lies in the responsibility of each customer. The products are not authorized for use in safety-critical applications without RECOM's explicit written consent. A safety-critical application is an application where a failure may reasonably be expected to endanger or cause loss of life, inflict bodily harm or damage property. The applicant shall indemnify and hold harmless RECOM, its affiliated companies and its representatives against any damage claims in connection with the unauthorized use of RECOM products in such safety-critical applications.